

# INSTALLATION PROCESS

TC-120 for use with 3/4" (19mm) decking

For TC-G (TC-150) for use with 1" (25mm) or thicker decking

# Tiger Claw<sup>®</sup>

## Hidden Deck Fasteners

153 Bowles Road • Agawam, MA 01001

Email: tigerclaw@deckfastener.com  
 Tech Support: 800-518-3569 toll free  
 Customer Service: 800-518-3569 toll free  
 Fax: 413-786-1760

### GETTING STARTED / INSTALLATION TIPS

**IMPORTANT!** Read all instructions carefully and completely to ensure proper installation.

**WARNING!** Parts have sharp points & edges. Use extreme caution when handling & installing. Wear safety glasses at all times.

#### Tools & Materials Needed



Safety Glasses



Power screw gun with ratcheting torque setting

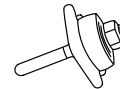

Tiger Claw Slot Cutter



Router

#### Step 1

#### INSTALL FIRST BOARD

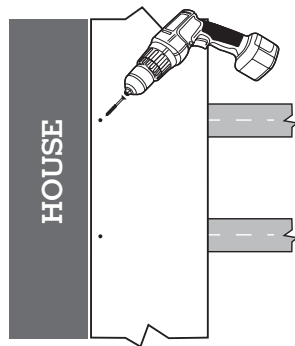

Fasten one edge of the first board at each framing support using a quality 2 1/2" (64mm) deck screw. It is important that this board is straight and well secured.

#### Step 3

#### INSTALL FIRST FASTENER

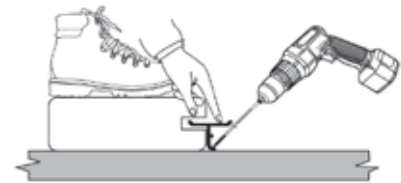

While standing on deck board, install provided screw at 45° angle through fastener and into joist, while applying pressure on fastener. Install one fastener and screw at each support joist.

Make sure fastener body is vertical to deck board and the screw is holding fastener down tight to support joist. adjust torque setting on screw gun to prevent spin out of the screw head.

#### Step 2

#### POSITION FASTENERS

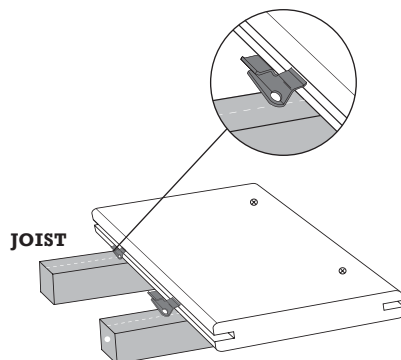

Fully insert TC-G or TC-120 fastener into grooved edge of deck board. Screw hole should line up with the center of support joist.

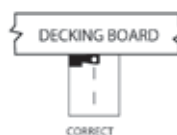
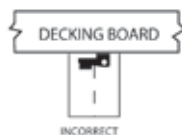

#### Step 4

#### COMPLETING INSTALLATION OF BOARDS

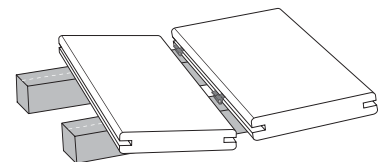

**a** Place next deck board into position against fasteners. Slightly raise outer edge of board being installed and slide board onto fastener until board contacts spacer tabs.

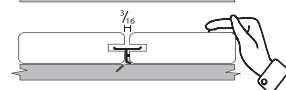

**b** Check gap between boards for consistency. Apply force to ensure board is fully installed.

Repeat steps 2 thru 4 until deck is complete.

# HELPFUL TIPS

## Coverage

- Multiply the number of joists by the number of decking boards to equal the number of fasteners needed.
- 90 fasteners will cover approximately 50 sq. ft. (4.6 m) using 5.5" (140mm) decking boards on 16" (410mm) centers or 35 sq. ft. (3.3 m) using 3.5" (90mm) decking boards on 16" (410mm) on centers.

## How do you attach the last board?

To finish, we recommend using either finish nails or trim screws to secure the last board along its edge. Or, you can angle a screw through the deck frame and into the bottom of the deck board.

## 45° angle installation

**When deck is in the walled corner of the house:** always start with small piece of decking in that corner and work your way out. **When installing TC Fasteners,** offset the center  $\frac{1}{2}$ " (13mm) towards the long point of joist, so screw will not exit side of joist when driven.

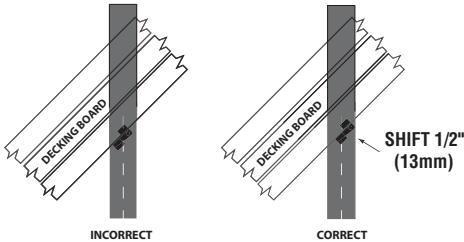

## How to do a butt seam

**For TC-G (TC-150):** Butt Seam clip is available to use with the TC-G (TC-150)

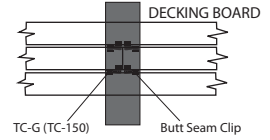

**For TC-120:** First, install a small framing board 10-12" (250-300mm) alongside the joist on which the seam is going to land. Install additional fastener into previous board above small framing block. Line up your first board in the center of the joist and the small framing board. Install fasteners and screw at each joist of the first board including the joist at the seam. Then install your second board in the same fashion, and place a second fastener at the seam attaching it to the small framing block. Be sure you follow the end-to-end gapping instructions provided by decking manufacturer.

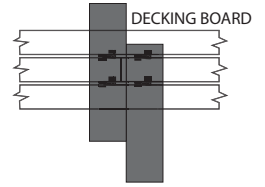

## How to replace a board

- Make two parallel cuts down the center of the board to be replaced, and remove the center piece.
- Using a small pry bar, remove the remaining pieces of decking from the tabs.
- Using a reciprocating saw, remove the tabs on the side of the board with the screw heads showing.
- Position new board into place, and carefully slide onto remaining tabs.
- Once board is set into position, secure the lead edge with finish nail, finish screw, or counter drill, screw and plug.

## To use the TC-G or TC-120 fastener on solid-edge boards

Use a router to create a groove at every intersection of the deck board and support joists, or groove the entire edge of the deck board.



**For TC-G (for use in 1" (25mm) or thicker decking):** Use the Tiger Claw TC-G Slot Cutter to create the groove shown below.

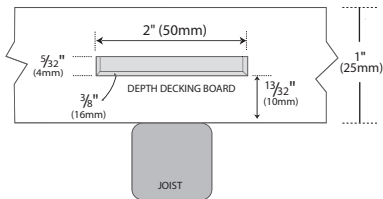

**NOTE:** The groove should start  $\frac{13}{32}$ " (10mm) above the **BOTTOM** of the deck board. Groove should be at least  $\frac{7}{16}$ " (11mm) deep.

**NOTE:** When using material with expected expansion greater than  $\frac{1}{8}$ " (3mm), in width allow additional spacing between deck boards. (Check with your lumber supplier for expected expansion in your area.)

**For TC-120 (for use with 3/4" (19mm) decking):** Use with Tiger Claw TC-120 Slot Cutter to create the grooves shown below.

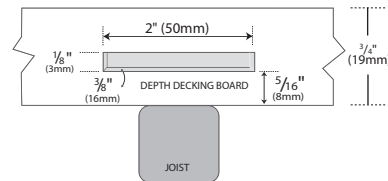

**NOTE:** The groove should start  $\frac{5}{16}$ " (8mm) above the **BOTTOM** of the deck board. Groove should be at least  $\frac{7}{16}$ " (11mm) deep.

**NOTE:** When using material with expected expansion greater than  $\frac{1}{8}$ " (3mm), in width allow additional spacing between deck boards. (Check with your lumber supplier for expected expansion in your area.)

## Remember: Tiger Claw has a fastener for all your decking needs:

**TC Pneumatic Installation Gun**  
For the fastest installation of TC-G

**TC-1 Softwood Deck Fastener**  
Coated Steel fastener for Pressure-Treated, Cedar, and Redwood

**TC-2 Softwood Deck Fastener**  
Stainless Steel fastener for Pressure-Treated, Cedar, and Redwood

**TC-3 Composite Deck Fastener**  
Stainless Steel fastener for Composite, PVC & Mahogany

**TC-4 Hardwood Deck Fastener**  
Stainless Steel fastener for Exotic Hardwoods

**Proclip Cellular PVC Deck Fastener**  
Stainless Steel fastener for AZEK decking

**TC-G Grooved Board Fastener**  
Stainless Steel fastener for 1" (25mm) grooved decking

**TC-120 Grooved Board Fastener**  
Stainless Steel fastener for 3/4" (19mm) grooved decking

**Butt Seam Grooved Board Clip**  
Stainless Steel clip to use in conjunction with the TC-G (TC-150) fastener.